

ЛГА061.003.00.00

возможна верт. установка

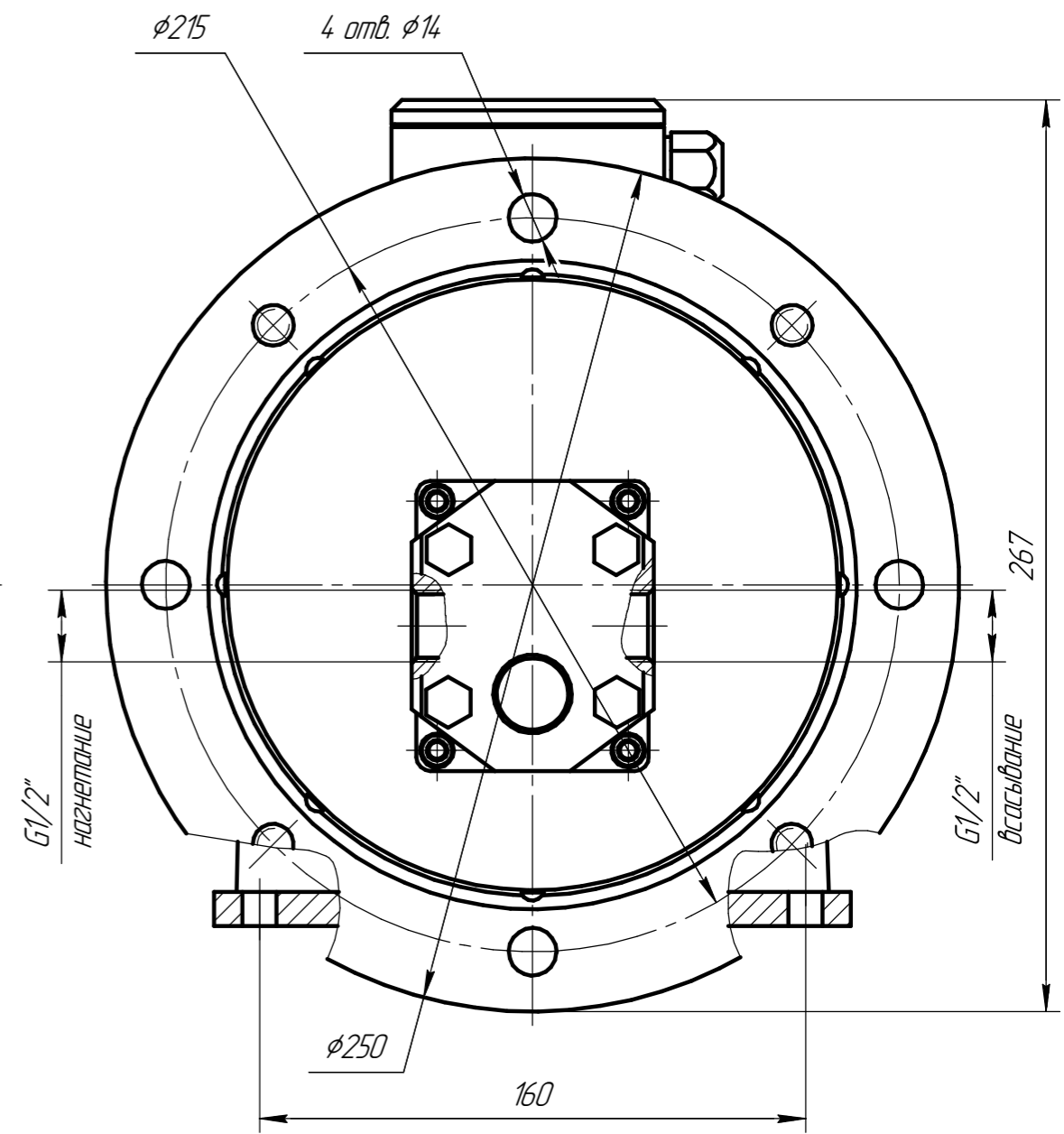
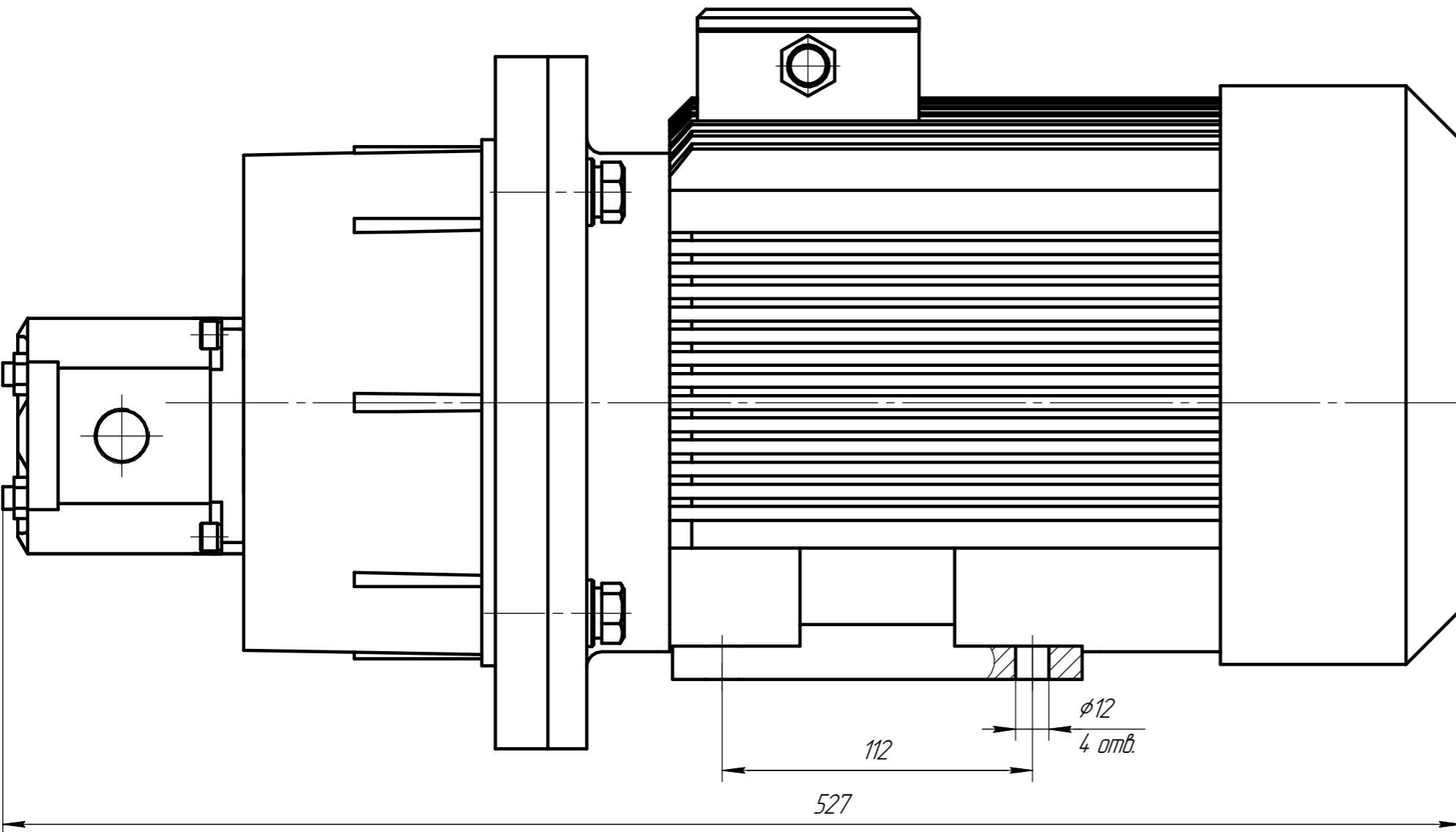

<i>Q, л/мин.</i>	<i>P, бар</i>	<i>n, об/мин</i>	<i>N, кВт</i>
<i>5,9</i>	<i>200</i>	<i>1500</i>	<i>3,0</i>