

ЛГА062.006.00.00

возможна верт. установка

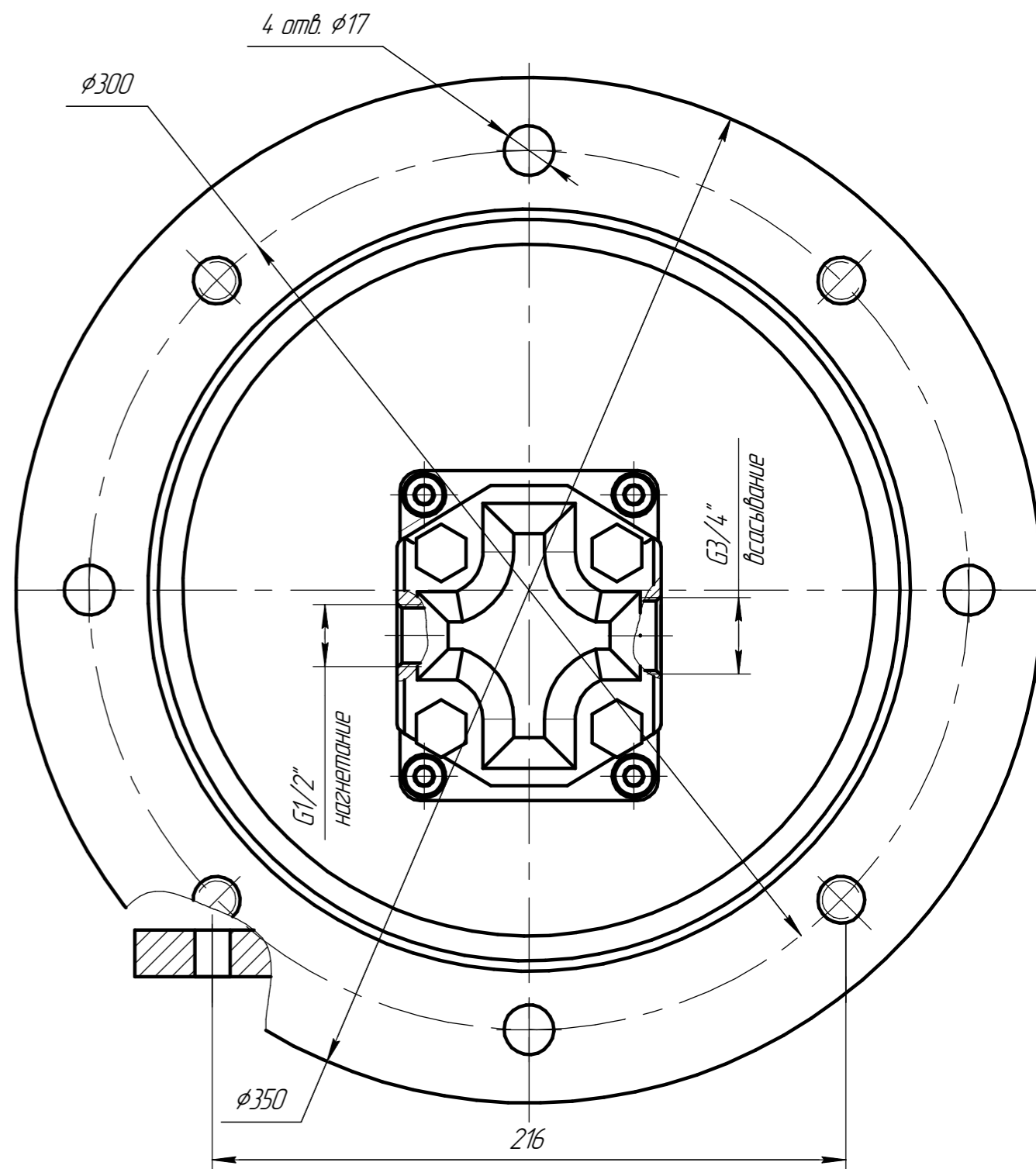
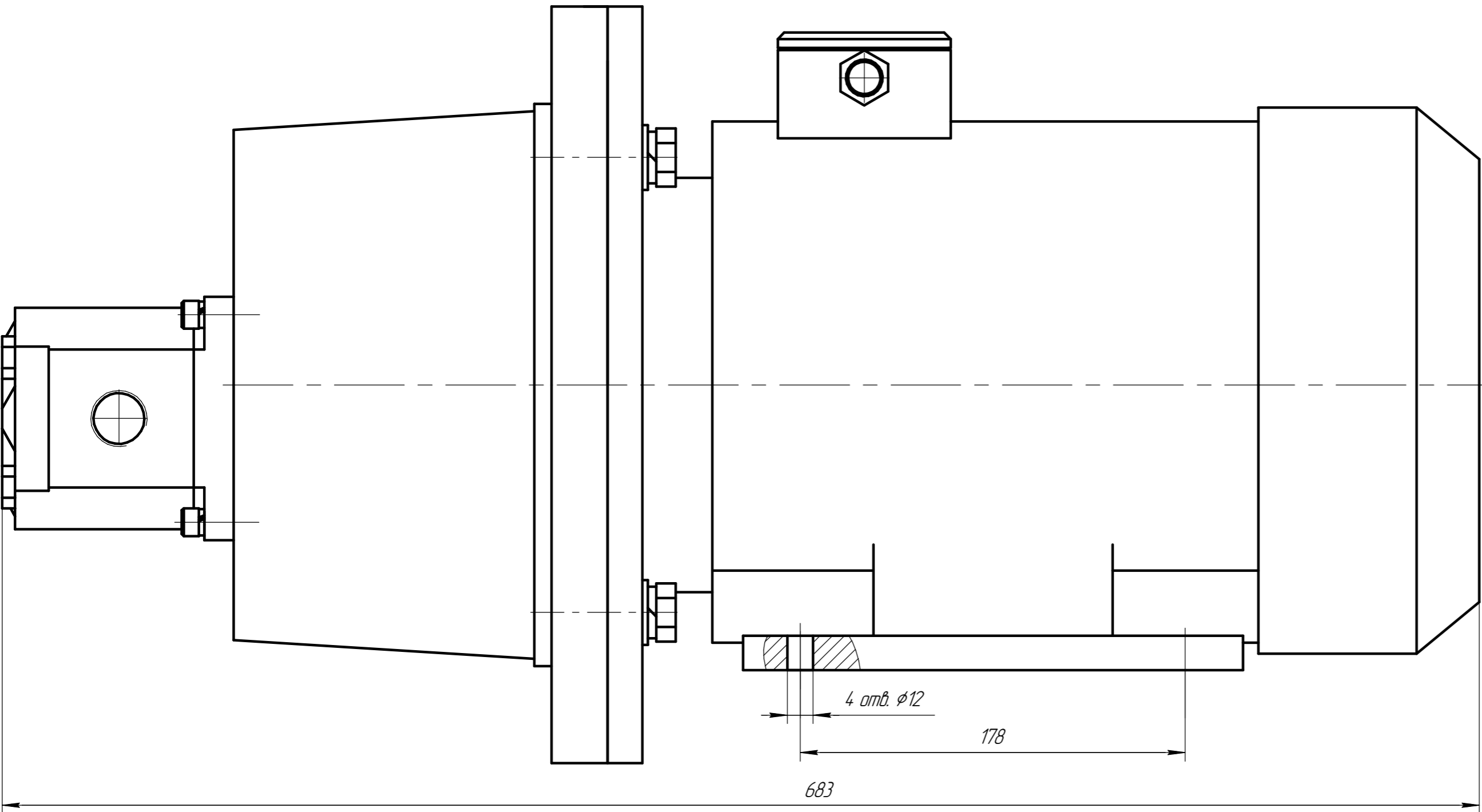

Q, л/мин.	P, бар	n, об/мин	N, кВт
20,1	260	1500	11