

ЛГА062.025.00.00

возможна верт. установка

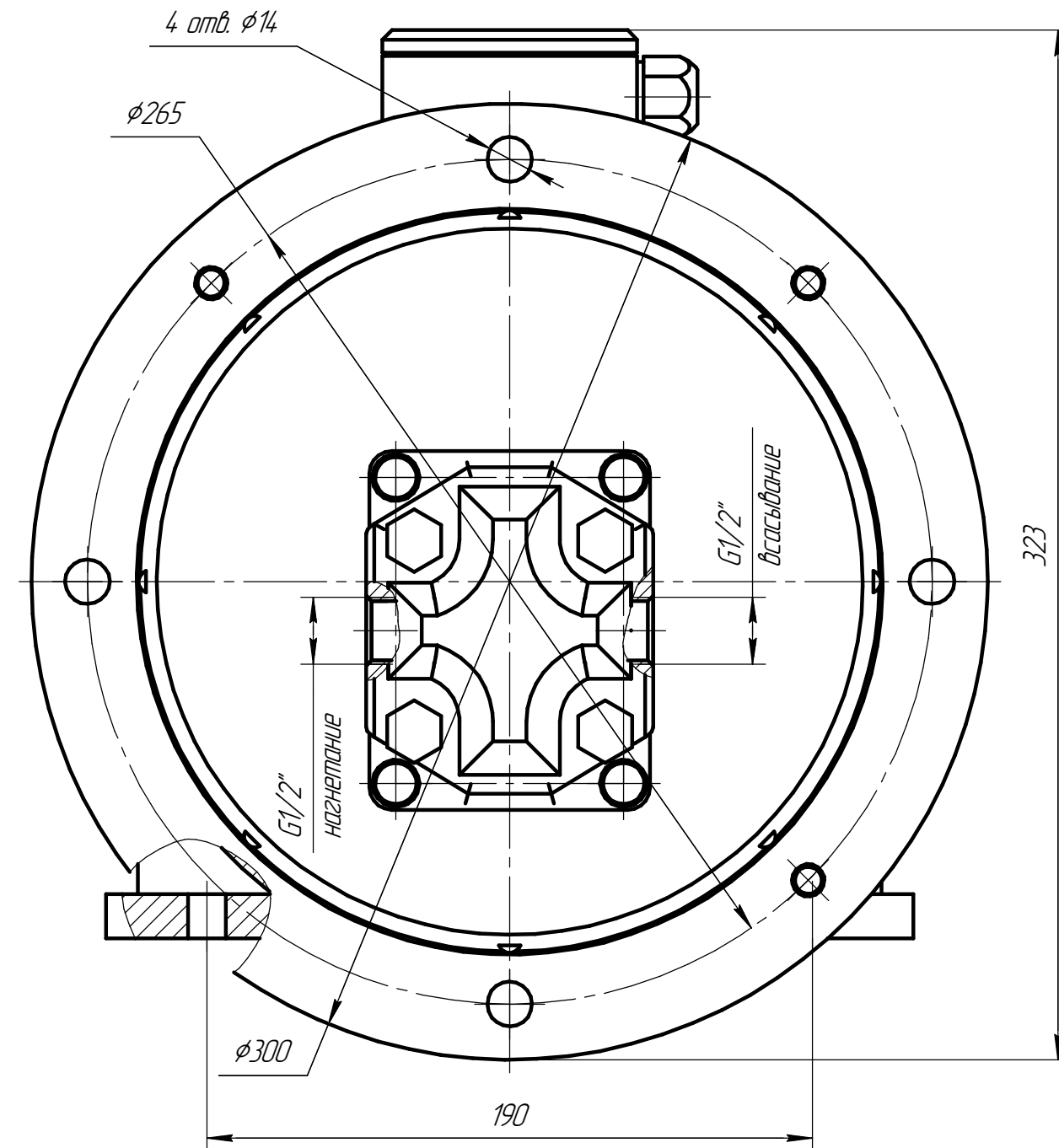
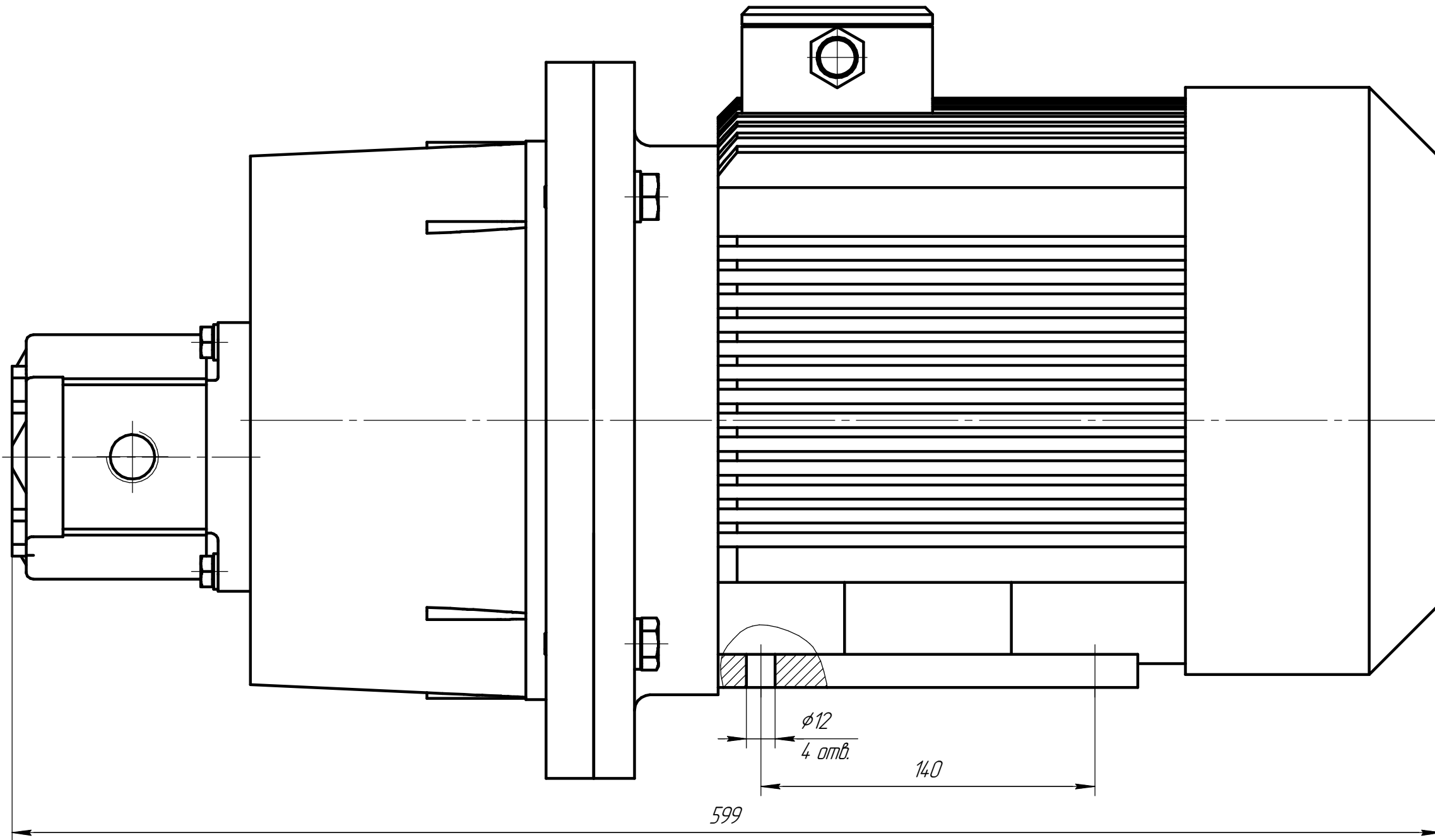

Q, л/мин.	P, бар	n, об/мин	N, кВт
13,7	200	1500	5,5