

ЛГА071.014.00.00

возможна верт. установка

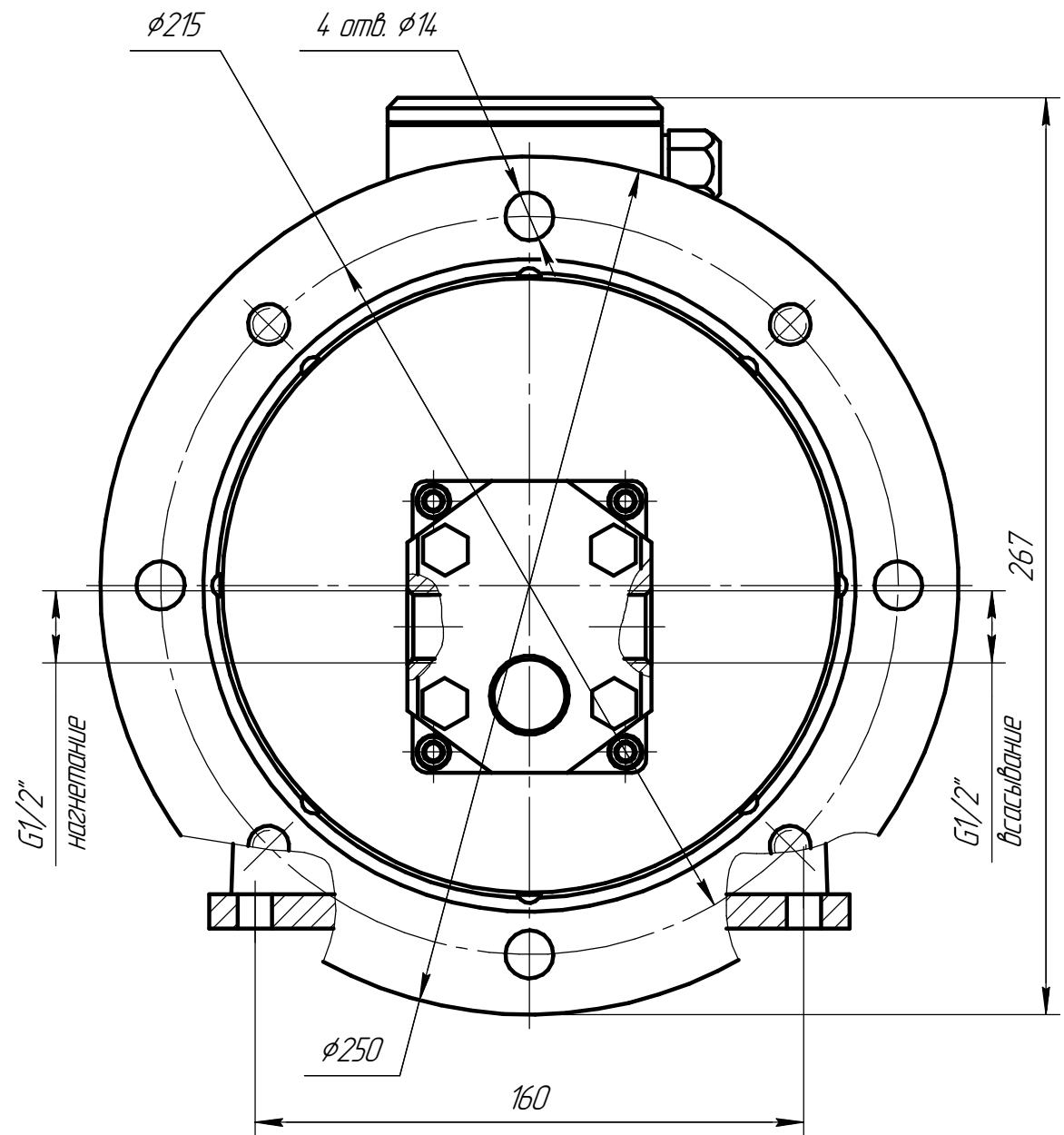
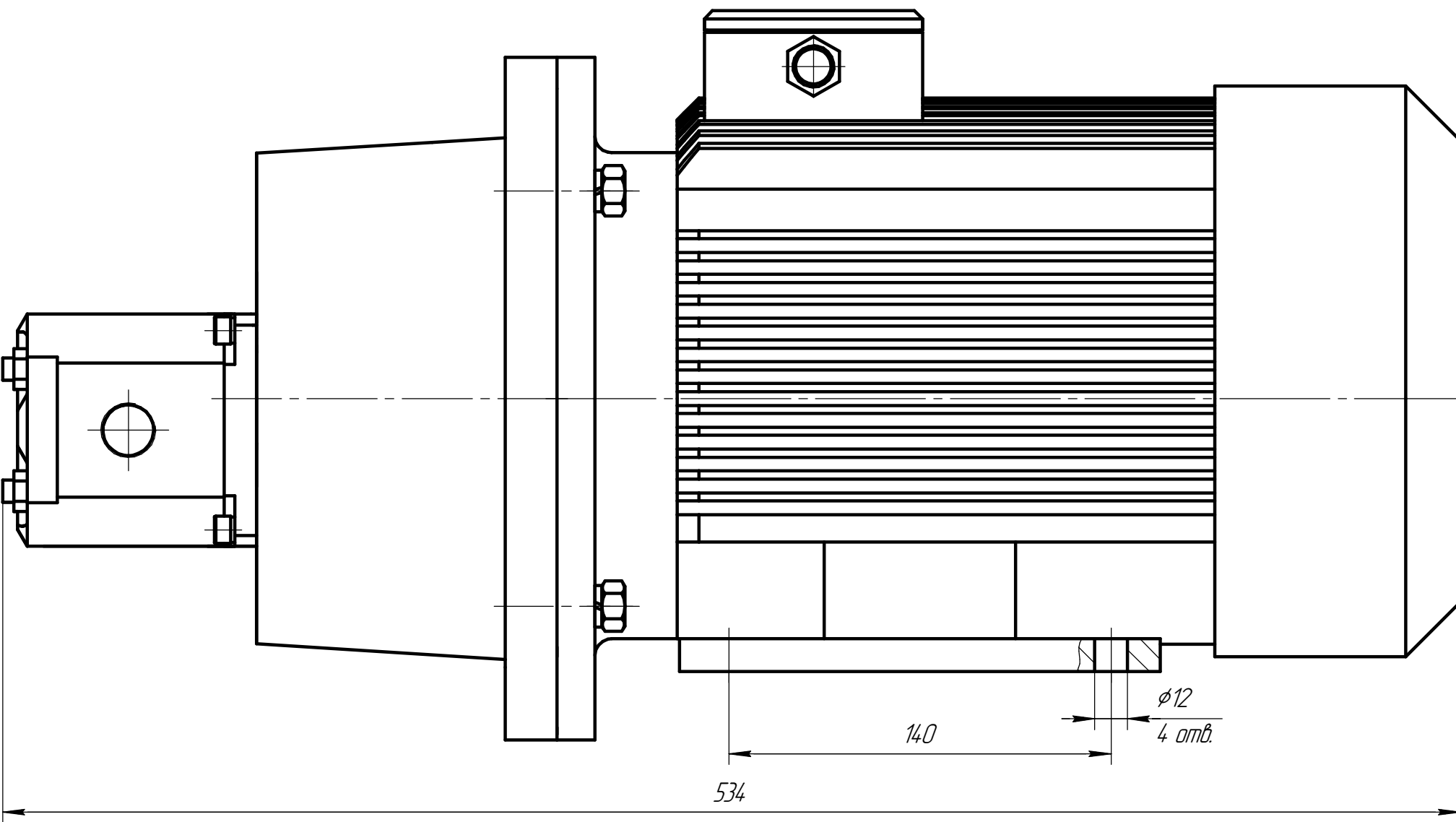

Q, л/мин.	P, бар	n, об/мин	N, кВт
8,8	200	1500	4,0